

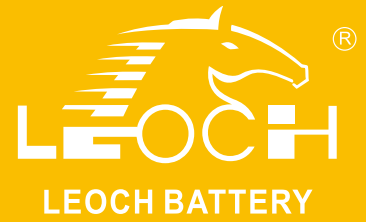

# LP Series-General Purpose

## LP6-4.5(6V4.5Ah)



### Specifications

Rated Voltage	6V	
Nominal Capacity	4.5Ah	(C <sub>20</sub> , 1.75V/cell)
Dimension	Length	70±1mm (2.76 inches)
	Width	47±1mm (1.85 inches)
	Container Height	100±2mm (3.94 inches)
	Total Height	106±2mm (4.17 inches)
Approx Weight	0.81 Kg (1.79 lbs)	
Terminal	T1	
Container Material	ABS	
Rated Capacity (25°C)	4.50 Ah	(20hr, 0.225A, 1.75V/cell)
	4.26 Ah	(10hr, 0.426A, 1.75V/cell)
	3.84 Ah	(5hr, 0.768A, 1.75V/cell)
	3.36 Ah	(3hr, 1.12A, 1.75V/cell)
	2.80 Ah	(1hr, 2.80A, 1.60V/cell)
Max. Discharge Current	68A (5s)	
Internal Resistance (25°C)	Approx 25mΩ	
Operating Temp. Range	Discharge	-15 ~ 50°C (5 ~ 122°F)
	Charge	0 ~ 40°C (32 ~ 104°F)
	Storage	-15 ~ 40°C (5 ~ 104°F)
Nominal Operating Temp. Range	25±3°C (77±5°F)	
Cycle Use	Initial Charging Current less than 1.35A. Voltage 7.2V~7.5V at 25°C(77°F)Temp. Coefficient -15mV/°C	
	Standby Use	
Effect of temp. to Capacity	40°C (104°F)	103%
	25°C (77°F)	100%
	0°C (32°F)	86%
Self Discharge	LP series batteries may be stored for up to 6 months at 25°C(77°F) and then a freshening charge is required. For higher temperatures the time interval will be shorter.	



### Layout

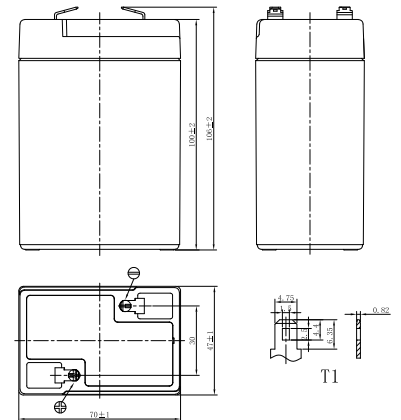

### Constant Current Discharge (Amperes) at 25 °C (77°F)

F.V/Time	5min	10min	15min	20min	30min	45min	1h	1.5h	2h	3h	4h	5h	6h	8h	10h	20h
1.85V/cell	12.8	8.74	6.97	5.67	4.19	3.08	2.53	1.87	1.49	1.09	0.876	0.747	0.646	0.509	0.416	0.220
1.80V/cell	13.7	9.27	7.31	5.89	4.32	3.16	2.60	1.91	1.51	1.11	0.889	0.758	0.656	0.516	0.421	0.223
1.75V/cell	14.4	9.64	7.55	6.06	4.43	3.23	2.65	1.95	1.54	1.12	0.901	0.768	0.663	0.522	0.426	0.225
1.70V/cell	15.1	10.0	7.81	6.23	4.55	3.30	2.70	1.98	1.56	1.14	0.913	0.778	0.671	0.527	0.430	0.227
1.67V/cell	15.7	10.3	8.00	6.36	4.63	3.36	2.74	2.01	1.58	1.15	0.922	0.785	0.677	0.531	0.433	0.229
1.60V/cell	16.6	10.7	8.27	6.55	4.75	3.44	2.80	2.05	1.61	1.17	0.938	0.797	0.687	0.539	0.439	0.231

### Constant Power Discharge (Watts/cell) at 25 °C (77°F)

F.V/Time	5min	10min	15min	20min	30min	45min	1h	1.5h	2h	3h	4h	5h	6h	8h	10h	20h
1.85V/cell	24.1	16.6	13.3	10.9	8.10	5.97	4.93	3.66	2.91	2.14	1.73	1.48	1.28	1.01	0.826	0.440
1.80V/cell	25.7	17.5	13.9	11.3	8.32	6.11	5.03	3.72	2.96	2.17	1.75	1.49	1.30	1.02	0.837	0.445
1.75V/cell	26.8	18.1	14.3	11.5	8.49	6.22	5.12	3.78	3.00	2.20	1.77	1.51	1.31	1.03	0.844	0.450
1.70V/cell	27.8	18.7	14.7	11.8	8.67	6.34	5.19	3.83	3.04	2.23	1.79	1.53	1.32	1.04	0.853	0.454
1.67V/cell	28.5	19.1	15.0	12.0	8.80	6.42	5.26	3.88	3.07	2.25	1.80	1.54	1.33	1.05	0.858	0.457
1.60V/cell	29.6	19.7	15.4	12.3	9.00	6.54	5.36	3.94	3.12	2.28	1.83	1.56	1.35	1.06	0.868	0.462



# LP Series-General Purpose LP6-4.5(6V4.5Ah)

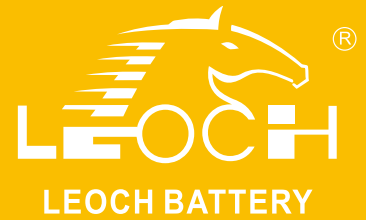

## Applications

- All purpose
- Uninterruptable Power Supply (UPS)
- Electric Power System (EPS)
- Emergency backup power supply
- Alarm and security system
- Communication power supply
- DC power supply
- Auto control system

## General Features

- 5 years design life(25°C)
- Special exhaust structure and sealing technology, safe and reliable, flexible installation, convenient maintenance
- PbCaSn alloy for plate grids: less gassing, less self-discharging
- High quality AGM separator: extend cycle life and prevent micro short circuit
- High purity raw material: ensure low self discharge rate

## Standards

- Compliance with IEC 60896 standards, EU Battery Directive
- UL, CE Certified
- Manufactured in Leoch®IATF 16949, ISO45001, ISO 9001 and ISO 14001 certified production facilities

## Discharge Characteristics

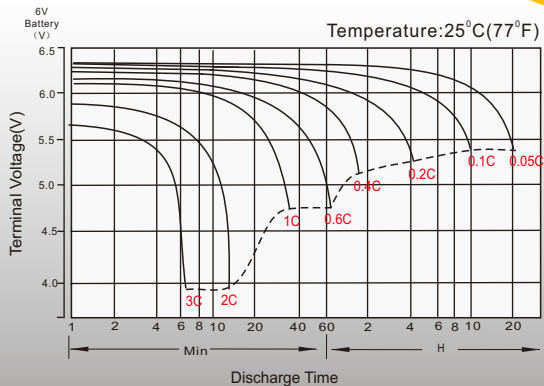

## Float Charging Characteristics

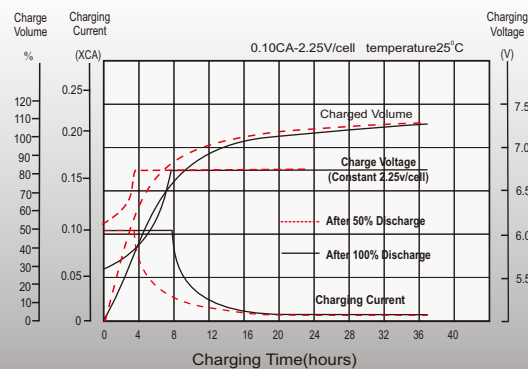

## Temperature Effects in Relation to Battery Capacity

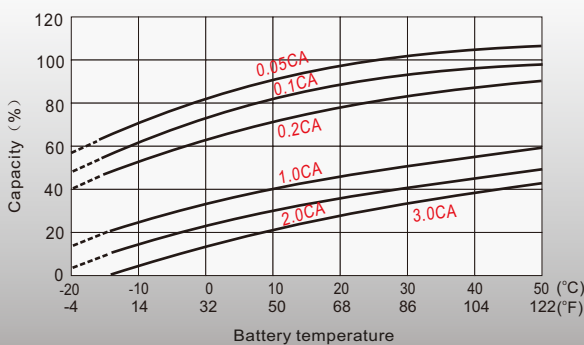

## Float Service Life

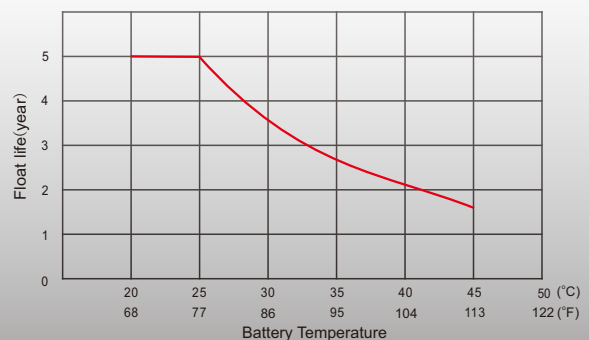

## Sales Offices Worldwide

### China Sales Office

5th Floor, Xinbaohui Bldg., Nanhai Blvd.,  
Nanshan, Shenzhen, China. 518052  
Tel: +86-755-86036060 (100 lines)  
Tel: 949-588-5853  
Fax: +86-755-26067269  
E-mail: export@leoch.com

### HongKong Sales Office

Workshop C, 33/F, TML Tower, No. 3 Hoi Shing Road,  
Tsuen Wan, New Territories, Hong Kong  
Tel: +852 35786666  
Tel: +44(0) 1452 729428 / 1452 729696  
Fax: +44 1452 690125  
E-mail: sales.hk@leoch.com

### Singapore Sales Office

No. 1 Tech Park Crescent,  
Singapore 638131  
Tel: +65 68636078  
Tel: +30 210 5760318 (2 lines)  
Fax: +65 6863 6079  
E-mail: sales.sg@leoch.com

### Australia Sales Office

2 /29 Tarlington Place, Smithfield, NSW 2164  
Australia  
Tel: 02 9756 0950  
E-mail: sales.au@leoch.com

### North America Sales Office

19751 Descartes  
Foothill Ranch, CA 92610, USA  
Tel: 949-588-5853  
Tel: 949-588-5966  
E-mail: sales@leoch.us  
Http:// www.leoch.us

### UK Sales Office

9B Wheatstone Court, Waterwells, Business Park,  
Gloucester, GL2-2AQ, UK United Kingdom  
Tel: +44(0) 1452 729428 / 1452 729696  
Tel: +44 1452 690125  
E-mail: Sales.Europe@leoch.com  
Http:// www.leoch.eu

### EMEA Sales Office

1 Deligiorgi St., 121 31 Athens,  
Greece  
Tel: +30 210 5760318 (2 lines)  
Tel: support\_EMEA@leoch.com  
Http:// www.leoch.eu

### India Sales Office

Shed no.A-53(b), 2nd Stage of Peenya Industrial Area,  
Bangalore North Taluk, Bangalore-560058, India  
Tel: +91-80-23440018/23440019  
Tel: +91-80-23440017  
E-mail: indiasales@leoch.com



[Http://www.leoch.com](http://www.leoch.com)

© 2020 LEOCH. All rights reserved.

Trademarks and logos are the property of LEOCH and its affiliates unless otherwise noted.  
Subject to revisions without prior notice.

Publication No.: LB-LP6-4.5-PD-EN-V2.0-202004